

GAIA PALAU



CONTENTS

04	Solitude Gaia Palau
07	Vessel Facts
08	Safety
09	Safe Diving
12	The Diving Specifications
14	Onboard Hospitality
16	About the Cabins
21	The Digital Area
22	Palau
26	Solitude Gaia Palau Itineraries
28	Classic Palau 8 Days 7 Nights
32	Palau New / Full Moon Spawning
34	Palau 11 Days 10 Nights
42	Solitude World
47	Connect With Us & Keep in Touch
48	3SIXTY Appreciation Program
50	Join Our Community





Solitude Gaia Palau

A scuba diving liveaboard that transforms the core experience of exploring and adventuring on the open ocean.

Completed in the year 2023, this vessel, stretching an impressive 40 metres in length, is more than just a ship; it's a testament to innovation and meticulous craftsmanship. With a robust steel hull, it stands as a symbol of stability, ensuring your safety and peace of mind throughout your diving journey. But that's not all; the Solitude Gaia Palau's aluminium superstructure adds a unique touch, not only contributing to its stability but also lowering the centre of gravity for an even smoother and more stable voyage.

What sets the Solitude Gaia Palau apart is not just its structural excellence but also its deep commitment to creating an environment where guests can truly feel at home. Designed to meet the highest standards of the classification society BKI and the stringent requirements for a passenger ship, it was crafted with the intent to share the profound passion and wonder of the world beneath the ocean's surface.

Stepping on board, you'll find that the Solitude Gaia Palau evokes a sense of freedom and openness that inspire freedom of the mind and a sense of openness. It encourages reflection on the timeless virtues that guide our lives: humility, charity, chastity, gratitude, temperance, patience, and diligence. These virtues are not just words; they are embedded in the very essence of the vessel, shaping your experience.

The curated décor, with its soothing neutral tones, offers a space that exudes consideration, intent, comfort, elegance, and a subtle touch of luxury. It's a deliberate choice, designed to reinforce gratitude and appreciation for the remarkable world that lies beneath the waves.

With a cruising speed of 10 knots, Solitude Gaia Palau offers a sense of serenity and adventure combined. It boasts nine cabins and a sumptuous spa suite, ensuring the utmost comfort for up to 18 guests. As you embark on your scuba diving journey aboard this remarkable vessel, you'll not only explore the ocean's depths but also embark on a voyage of self-discovery, where the virtues of the sea and the vessel itself converge to create an experience like no other.



VESSEL FACTS

Solitude World, a privately held company headquartered in Singapore, oversees the operations of the impressive Solitude Gaia Palau, which proudly stands as the third vessel within the Solitude Fleet.

Type and Year Built Steel Mono-Hull with aluminium superstructure, launched in 2023.

Port of Registry/Flagged Koror, Palau

Cruising Itinerary Routes Palau

Length 40m (meters) **Beam** 9m **Draft** 2.3m or
Length 131.24ft (feet) **Beam** 29.53ft **Draft** 7.55ft

Cruising Speed 10 Knots, top speed 14 Knots

Diesel Capacity 62,256L (16,459.25 US Gal.)

Cruising Range is approximately 9000 nautical miles (16,668 km).

Engine & Propulsion twin Yanmar engines 829 HP @ 1900 RPM.

Electricity 2 x Baudoin 6W105S rated 107KW-1500RPM and 1 x Weichai WP4CD66E200 50KW/62.5KVA 3PH 50Hz generators providing 24 hours of 200V to 240V - 50Hz power.

Navigation equipped with local navigation maps, GPS chart plotter, radar (long/short range), weather plotter, and depth sounder.

Communication System VHF/SB radios, Garmin inReach mini II with 2 way satellite text messaging and SOS distress, Starlink internet.

Ship Safety System GMDSS with EPIRB, AIS, life rafts, emergency survival packs, and a semi-automated fire suppression sprinkler system.

Fresh Water Capacity 63,086L (storage) with 3 onboard water-makers each capable of producing 280L of fresh water per hour.



SAFETY

SAFETY is Solitude's top priority, we take every precaution to ensure the safety of our guests and crew. As we operate in remote areas we ensure that we are well-equipped to handle any emergency scenario.

During your stay onboard we provide our guests with a complimentary Nautilus Marine Rescue GPS to provide that peace of mind when out diving in the remote parts of Palau and the Philippines.

Our Features & Global Maritime Distress and Safety System (GMDSS) equipped with:

- Emergency Position-Indicating Radio Beacon (EPIRB)
- Life Rafts
- Emergency Survival Packs
- Semi-Automated Fire Suppression Sprinkler System
- VHF/SB Radios
- Garmin inReach mini II with 2 way satellite text messaging and SOS distress
- Inmarsat-C
- Starlink Internet
- Local Navigation Maps with Furuno GPS Chart Plotter
- Radar (Long/Short)
- Weather Plotter
- Depth Sounder
- 63,086L Water Storage with On-board Water-Makers capable of producing 280L of fresh water per hour.

SAFE DIVING

We understand that your time and investment in a holiday are valuable, and we aim to provide you with as many dives as possible while ensuring your safety.

To prioritise safety, we require a minimum of 6 hours of rest before your first dive this will ensure that you are well-rested and hydrated before your first dive.

We recognise that although you have learned about safety during your scuba course/s, the excitement and anticipation of a diving holiday can sometimes cause us to neglect our own readiness for a dive.

Our crew's safety is also important, so we limit the number of dives to four per day, including a night dive, to minimise fatigue and reduce the risk of accidents.

Itineraries are subject to change due to weather and logistics, but our cruise directors will keep you informed.

Dive Site: Jake Seaplane



THE DIVING SPECIFICATIONS

We aim to provide you with as many dives as possible while ensuring your safety.

Dive Skiffs there are two purpose-built aluminium boats measuring 6m each, equipped with single 100HP outboard engines.

Support Skiff purpose-built aluminium boat measuring 6m, equipped with single 100HP outboard engine.

Air Compressors 3 x Bauer Poseidon compressors

Nitrox Membrane System Aaragon

Dive Guides ratio 1 to 6 divers. Private guide service is available with advance notice for USD150 per diving day (pdd).

Dive Equipment Rental is available, which includes dive computers, but underwater cameras are not included.

Nautilus Lifeline MARINE Rescue is complimentary Nautilus Lifeline Marine Rescue GPS. Please Note that if you use the Device, you are responsible for replacing it if lost or damaged.

Surface Marker Buoy (SMB), Lead Weights & Belt are complimentary but you will be responsible for replacement if lost or damaged.

Enriched Air Nitrox Diving EANx 28 to 32%, to provide a more suitable M.O.D for divers.

YES%

Enriched Air Nitrox

For safety reasons, we typically provide EAN mixes of around 30% to 31%, which allows for a safer Maximum Operating Depth and ample bottom time. Our all-inclusive diving package can include EAN use, proof of EAN certification is required without exceptions.

Dive Shop

Although our dive shop has limited retail space, we do offer rental equipment to accommodate your needs. To ensure a smooth experience, we kindly request advanced notice if you require rental gear. In the event that you encounter the need for repair or spare parts, we will make every effort to assist you to the best of our ability. Please note that the cost of any required parts will be assessed on a case-by-case basis. It is highly recommended that you have your own gear serviced and thoroughly checked prior to your arrival for optimal diving conditions.

Prior to diving, it is mandatory to present proof of certification and insurance.

Scuba Cylinders of various DIN sizes (York Adaptors available). Twin tanks are not available, side-mount configurations supported.

Rebreather Support only on full charters with rebreather divers. Organising scrubbers requires advanced notice of 60 days or more, although there is no guarantee. Alternatively, you have the option to order and send them to us. It's important to note that oxygen supply in Palau is both limited and costly.

Medical Oxygen and Comprehensive First Aid Kits are available

NO SOLO diving is allowed, even if you are certified.

It is mandatory for all guests engaging in scuba activities to have an audible signalling device (such as a whistle), a dive computer, a surface marker buoy, appropriate dive insurance coverage, a valid dive certification, and have completed waiver forms A and C for the activities.

Dive Centre

1	EANitrox prices are as follows: USD8 per dive OR USD20 per day	Yes
2	100 cu.ft. / 15L cylinders - additional charge USD10 per cylinder per diving day (pcpdd)	Yes*
3	Side mount support - additional 12L/80cu.ft. cylinder available. Air USD10, EANitrox USD28 pcpdd. Whole trip use: 10% discount applies	Yes*
4	DIN valves with option of Yoke (A-clamp)	Yes
5	Rebreather diving costs only USD0.06 per litre* for oxygen filling. Dive profiles must consider other guests' comfort and safety. Helium, if required, may be costly. Full charter profiles are not limited to standard recreational limits.	Yes
6	Rental gear available	Yes*
7	Private Guide Service is available for USD150 pdd.	Yes*

* Subject to availability/change



ONBOARD HOSPITALITY

Welcome aboard Solitude Gaia Palau, where our exceptional hospitality ensures a journey of tranquillity and comfort unlike any other.

Entertainment onboard entertainment includes smart TVs installed in every cabin, lounge, and dining area. The lounge features a Bose audio system designed to elevate your viewing experience, complementing the 65-inch smart TV. Additionally, guests have access to cards and board games for their leisure and enjoyment.

Types of Coffee Available onboard, there is a fully automatic (self-service) ground coffee machine, local and instant coffee.

Types of Tea Available onboard, we maintain a diverse selection that includes Chamomile, English Breakfast, Ginger, Green, and Chinese teas, subject to availability.

Drinking Water free flow from potable water dispenser with additional 4-stage filtration.

Alcoholic Beverages Available* beer, red/white/rose wine, and popular liquors, you may also BYO (within reasonable amounts, e.g. Palau duty-free allowance) with no corkage charge. We do not

allow any request to assist in personal purchases to stock alcoholic beverages as we conduct sales of alcoholic beverages on board. Non-alcoholic Beverages are subject to availability, popular selections include light and zero options.

Self Serve Snacks are available 24 hours. Ice Maker available.

Special Dietary Requests with prior notice, we can cater to vegetarian and selective non-meat diets. However, for vegans, we kindly request advanced notice and a specific list of allowable ingredients for their meal preparation.

Souvenirs* Solitude Gaia Palau apparel is still in progress, however, local souvenirs can be purchased when we take you to the local shopping mall.

Onboard Guest Services* Starlink internet and laundry services are available.

* additional cost

ABOUT THE CABINS

The cabins are exquisitely crafted, shaped by years of expertise to incorporate design elements that elevate your comfort at every turn.

Step into Solitude Gaia Palau, where comfort and adventure meld seamlessly. With nine (9) meticulously designed cabins accommodating up to 18 guests, the vessel mirrors thoughtfulness, elegance, and opulence. Each cabin, a tranquil oasis on the open sea, epitomises relaxation and sophistication. Neutral tones and graceful furnishings create a timeless ambience, fostering reflection and rejuvenation.

These spaces embody Solitude Gaia Palau's unwavering commitment to excellence, offering a spacious and inviting environment where you can unwind, connect with fellow travellers, and reconnect with yourself. It's a world where the tranquillity of the sea harmoniously coexists with the luxury of life aboard Solitude Gaia Palau during your voyage.

OVERVIEW - 9 Cabins in Total

Upper Deck | 3 cabins in total, 303, 302, 301: 2 x Ocean View Staterooms (2 Twin or Double Sharing), 1 x Ocean View Cabin (Double Sharing)

Main Deck | 4 cabins in total, 204, 203, 202, 201: 4 x Ocean View Cabins (2 Twin and Double Sharing)

Below Deck | 2 cabins in total, 102, 101: 2 x Interior Cabins (Twin or Double Sharing)

Mattress Sizes

- King Mattresses 198cm x 202cm (Cabins 201 and 202)
- King Mattress 182cm x 202cm (Cabin 303)
- Single/Twin Mattresses 102cm x 202cm or 204cm x 202cm (Cabins 301, 302, 203, 204)
- Single/Twin Mattresses 100cm x 198cm or 200cm x 198cm (Cabins 101 and 102)

En-suite

Every cabin and stateroom on board is equipped with an en-suite shower (providing both hot and cold water) and a WC featuring a common water-flush system.)

Cabin Comforts

Individual air conditioning system with climate control

- A safe deposit box
- Bathrobes, face and bath towels
- Hair dryer
- Intercom
- Television
- Body wash, Shampoo and Conditioner



- Bedding including pillows, duvet, and sheets. Extra pillows and light blankets are available on request
- Wardrobe organiser with ample hangers
- Desk with universal electrical points conveniently located for gadgets

En-suite Shower and Toilet

The cabin en-suite showers and toilets are thoughtfully designed to cater to the needs of modern-day users. While the size may vary depending on the cabin category, even the most compact cabins provide sufficient room, shelving, and space to accommodate your personal toiletries. All en-suite facilities are equipped with the following amenities:

- Manual bidet gun
- Separate shower
- Shelves, robe hooks and towel hanging space

Housekeeping Practice

Cabins are cleaned daily. Sheets, bath and face towels are changed every 3 days of use. However, please feel free to request a change at any time when necessary.

Gratuity / Tips

Throughout your stay, our dedicated staff and crew are fully committed to ensuring you have a fantastic Solitude experience, and while gratuities are not expected, they are sincerely appreciated. They recognise the collective teamwork, even from those working behind the scenes, and distribute all tips equally. Should you wish to show your appreciation, a recommended gratuity of 5% to 10% of the total stay cost is suggested. Of course, if you wish to express your appreciation with a higher amount, you are more than welcome to do so.

The Cabins Floor Plan

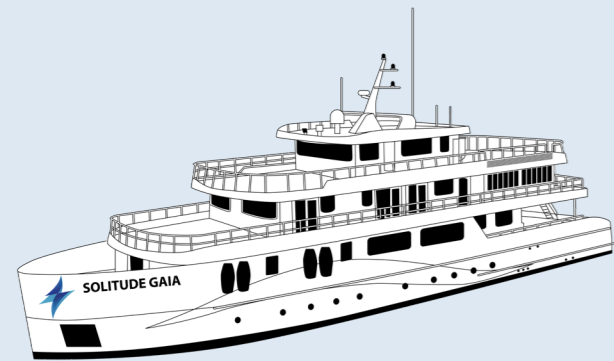

BELOW DECK INTERIOR CABINS LAYOUT

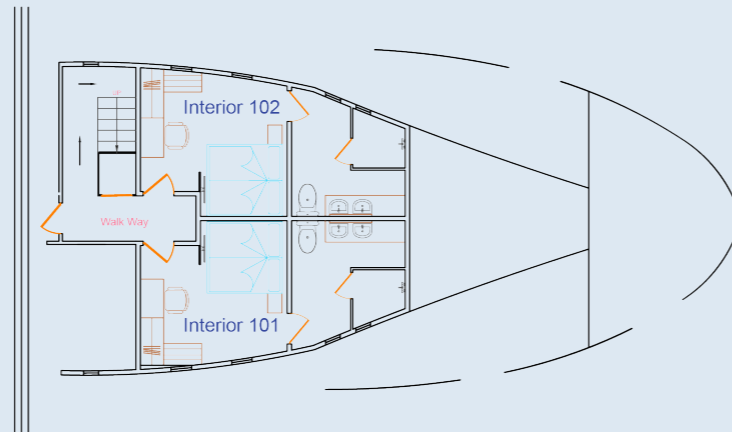

Interior Cabins 101 & 102 - Twin/Double Share

STATEROOM & UPPER DECK CABIN LAYOUT

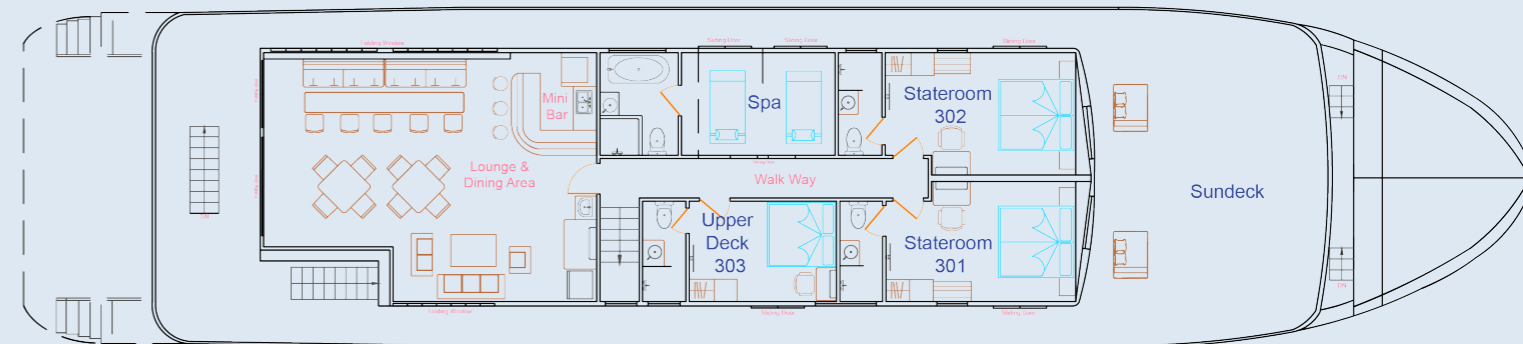

Stateroom 301 & 302 - Twin/Double Share
Upper Deck 303 - Double Share

NAVIGATION DECK

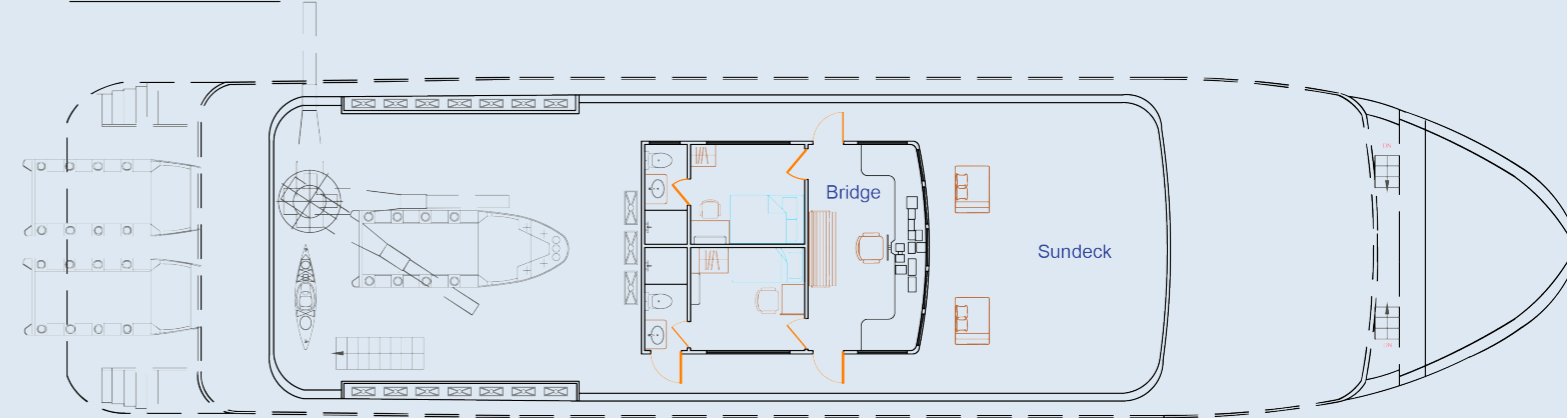

MAIN DECK CABIN LAYOUT

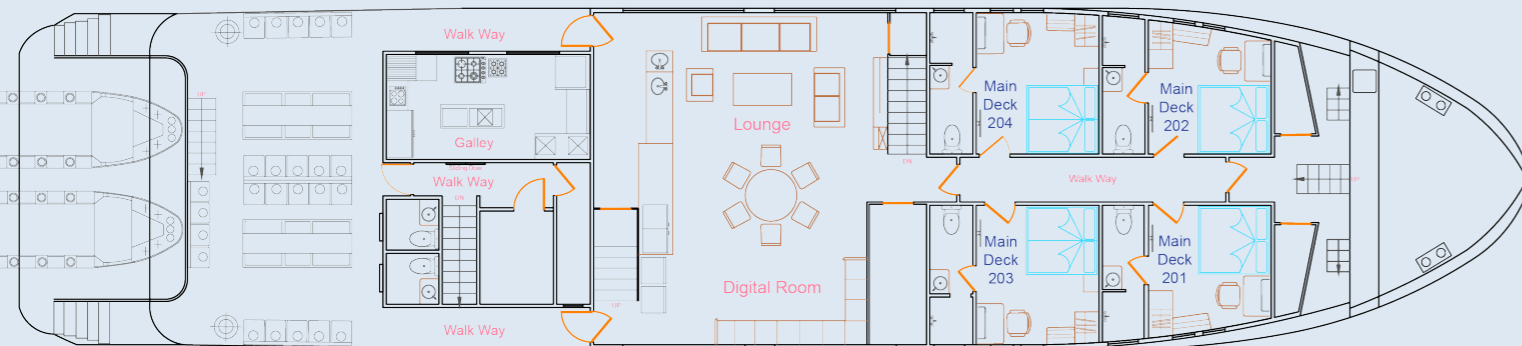

Main Deck Cabins 201 & 202 - Double Share
Main Deck Cabins 203 & 204 - Twin/Double Share





THE DIGITAL AREA

Our digital area can cater for all your electronic needs.

The ocean offers an idyllic haven for photographers, brimming with opportunities to capture rare and mesmerising marine life.

Located on the main deck, our dedicated digital room is thoughtfully equipped to support your creative process. Enjoy air conditioning, moisture filters, and spacious workstations with [universal](#) power points—designed for comfort and convenience.

To keep your equipment in top condition, we offer freshwater rinse basins and large camera tanks, on the dive deck, along with air guns and towels for easy drying and maintenance after each dive.

[Universal](#) power sockets (200V–220V, 50Hz) are available in both guest cabins and the digital studio, while the digital room also features surge protection and UPS outlets for added peace of mind.

Social Media

We encourage you to share your encounters with the fascinating new critters you'll undoubtedly encounter, as well as your enjoyable experiences with us. Feel free to tag us on social media platforms:

Instagram:

[@solitude.gaia](#)

[@solitude.world](#)

Facebook:

[@solitude.gaia](#)

[@solitudeliveboardsandresorts](#)

PALAU

The Land of Rainbows

Palau, a tropical paradise nestled in the western Pacific Ocean, is a diver's dream come true. Renowned for its breathtaking natural beauty, this archipelago of over 500 islands offers an unparalleled diving experience that is sure to leave every adventurer in awe.

With crystal-clear turquoise waters teeming with vibrant marine life and an abundance of thriving coral reefs, Palau boasts some of the most diverse and pristine diving sites in the world. From towering limestone islands and dramatic drop-offs to intricate underwater caves and World War II wrecks, the underwater landscape of Palau is a true wonder to explore.

Divers can embark on thrilling encounters with majestic manta rays, graceful sea turtles, and colourful reef fish. Palau is also famous for its thrilling shark encounters, where divers can witness the mesmerising sight of dozens of sharks gliding effortlessly through the deep blue.

One of the most iconic dive sites in Palau is the world-famous Blue Corner, where strong currents attract an impressive array of marine species. Other must-visit sites include the Blue Holes, Ngemelis Wall, and the German Channel, known for its encounters with graceful manta rays.

Beyond the remarkable underwater world, Palau offers a plethora of topside attractions. Visitors can explore lush jungles, hidden waterfalls, and ancient rock islands. Cultural encounters with the indigenous Palauan people provide a fascinating glimpse into their rich heritage and traditions.

With its pristine diving conditions, diverse marine life, and natural wonders both above and below the water, Palau is a true haven for adventurous divers seeking an unforgettable journey into the depths of paradise.

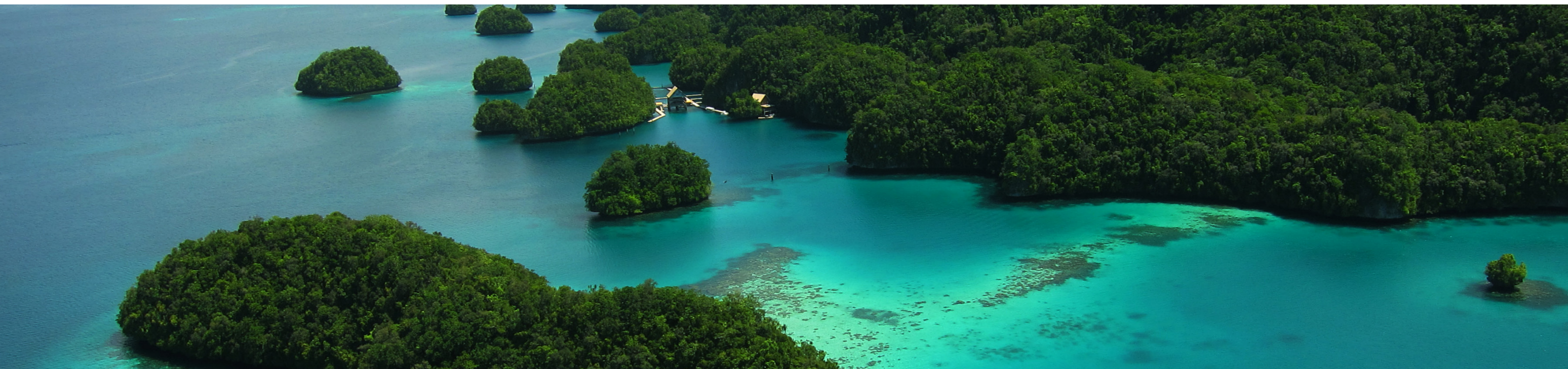

Malakal Marine Park



Contact Us

address: Solitude Gaia Palau

phone: +65 8243 4548

emailus@solitude-liveboards.com



Climate

Palau is the 'Land of Rainbows' with a tropical Climate with an annual mean temperature of 27°C (82°F). Rain is frequent between the months of June to October. Periodic rain flashes do occur.



Water Temperature

Ocean temperatures in the Palau range from 26°C to 29°C (81°F - 84°F).



Time Zone

Time Zone: GMT +9



Language

The official language is **Palauan and English** in Palau.



Currency

The currency is USD. Credit cards are widely accepted in Palau, though Amex and Diners are not commonly accepted. Solitude Gaia Palau accepts Mastercard, Visa, Discover, Diners and JCB.



Wifi

Guests can pre-purchase data packages to stay connected, while 3SIXTY members enjoy a complimentary data quota. Our Reservations team or Cruise Director will share the latest packages and pricing for your convenience.



Electricity

On board, Solitude Gaia Palau uses universal sockets compatible with EU, USA, AUS, UK, CN, etc. On land, the electrical system on land is identical to that of the USA, (single phase 60 cycles, 115/230 volts AC).



Duty Free

Palau has no general import tax. Duty-free allowances include one pack of cigarettes, 2 litres of alcohol, and goods up to \$400. E-cigarettes are banned—surrender them to avoid fines. Declare cash over \$10,000. For more details, please visit pristineparadisepalau.com/customs.



Dive sites of Palau



Solitude Gaia Palau
ITINERARIES





Classic Palau 8 Days 7 Nights

Day 1, Embarkation

Begin your adventure with a warm welcome and an orientation on board Solitude Gaia Palau. Boarding starts at 5:00 pm and concludes no later than 10:00 am on Day 2. Complimentary airport and local hotel transfers are available. As you step aboard, our team eagerly awaits to greet you. Registration and the collection of Permits and National Parks fees will follow. Remember to bring your C-Cards and/or Log Books. After settling into your comfortable accommodations, enjoy a delicious lunch and dinner, both included in your package, as you familiarise yourself with the vessel and meet fellow adventurers.

Day 2

Dive opportunities: 2-3 dives

Choice of sites: Iro Wreck, Chandelier Caves, Jake Seaplane, Hafa Dai Wreck

Today signifies the onset of our diving escapades, with Solitude Gaia Palau stationed in Malakal Bay. This area, steeped in World War II history, offers numerous shipwrecks and an airplane wreck to explore. Begin with an exploration of the Iro Wreck, where the remnants of a sunken Japanese warship await. The nearby Chandelier Caves present a beginner-friendly cavern dive with stunning stalactites. For a unique experience, dive into the Jake Seaplane site, where a sunken aircraft rests on the ocean floor. Later in the day, we embark on a 1-2 hour journey towards Ulong Island, setting the stage for more diving adventures.

Day 3

Dive opportunities: 3-4 dives

Choice of sites: Sandy Paradise, Ulong Channel, Siaes Corner, Siaes Tunnel, Shark City

Anchored near Ulong Island, we explore its picturesque, extensive white sand beach and ancient rock art paintings. Renowned for its numerous acclaimed dive sites, this area offers channels, walls, current-rich corners, and breathtaking reefs. Dive into the vibrant underwater world of Sandy Paradise, navigate the thrilling currents of Ulong Channel, or explore the depths of Siaes Tunnel. Weather permitting, we might have a beach outing with a BBQ, adding a touch of leisure to our diving adventure.

Days 4 - 6

Dive opportunities: 3-4 dives each day

Choice of Sites: Peleliu Cut, Yellow Wall, Peleliu Express, Orange Beach, German Channel, Blue Corner, Blue Holes, New Drop-off, Turtle Cove, and more.

Over these days, we dive in the southern region of the Rock Island Southern Lagoon and the outer reefs of Palau. Experience stunning dramatic drop-offs, thriving coral gardens, robust currents, and diverse marine life. Explore the rich history and marine biodiversity of Peleliu Island with dives at sites like Peleliu Cut and Yellow Wall. At German Channel, encounter manta rays gliding gracefully through the water. The renowned Blue Corner and Blue Holes offer thrilling diving experiences with an abundance of marine life. There's also an opportunity to partake in a World War II land tour of Peleliu Island, adding a historical dimension to your adventure.

Day 7

Dive opportunities: up to 3 dives. Your last dive must comply with an 18-hour no-fly/no-altitude rule.

Choice of Sites: German Channel, Ngedebus Wall, Dexter's Wall, Ngemelis Coral Garden, Virgin Blue Hole

On this final day of our diving expedition, we partake in two morning dives within the central area of Ngemelis Island. Dive into the vibrant underwater landscapes of German Channel and Ngedebus Wall, or explore the captivating depths of Virgin Blue Hole. After our dives, lunch will be served as we sail back to Malakal. In the afternoon, enjoy complimentary tours via speedboat through the Rock Islands and to the Milky Way. Note that a permit is required to visit these locations. We'll also brief you on check-out bills and payment arrangements.

Day 8, Disembarkation

No Dive Day

After a hearty breakfast, guests have the option to take complimentary speedboat tours through the Rock Islands and the Milky Way. Note that a permit is required to visit these locations. Lunch will be served before disembarkation, followed by farewells to the crew.

Disembarkation commences after lunch and will conclude at 5:00 pm. Early disembarkation is possible, but please be aware that missed meals, tours, or dives due to this change are non-refundable and non-exchangeable. We look forward to welcoming you back soon!

Please note that the itinerary and planned route may be altered due to unfavourable weather conditions, sea conditions, or restrictions imposed by local authorities.

Dive Site:
German Channel





Bumphead Parrot
Fish Spawning,
William Tan

Palau New / Full Moon Spawning

In sync with our Classic Palau itinerary, Solitude Gaia Palau Palau introduces a series of alluring expeditions through its specialised New and Full Moon Spawning Itineraries, offered in both 7 nights / 8 days and extended 10 nights / 11 days formats. Each curated journey is thoughtfully crafted to immerse you in the captivating natural spectacle of reef fish spawning events. These enthralling moments offer a rare, close-up window into complex fish behaviour, revealing the intricate rhythms and seasonal choreography of marine life.

Whether joining the shorter focused departure or the longer expedition that allows for deeper exploration across Palau's diverse reef systems, guests will experience dedicated effort towards encountering these phenomena. Species observed during spawning periods may include the magnificent bumphead parrotfish, vibrant red snapper, graceful Moorish idol and others.

However, it is important to understand that sightings and behaviours may vary, influenced by

seasonal transitions, specific reef locations and the ever-shifting pulse of ocean currents.

While our itineraries are planned with lunar cycles and historical spawning patterns in mind, these events remain guided entirely by nature. As such, precise timing, species presence and intensity of activity cannot be guaranteed.

To maximise the opportunity for meaningful encounters, routes and daily schedules remain intentionally flexible. This adaptive approach allows the expedition team to respond intuitively to real-time conditions and observed marine behaviour. Guests are therefore invited not just on a voyage, but into a living seascape where nature's quiet signals shape the path forward.

Join us for an extraordinary venture into Palau's depths, where patience, curiosity and wonder come together, and where the ocean's most mesmerising gatherings unfold in their own time.

Palau

11 Days 10 Nights

Day 1, Embarkation

Begin your adventure with a warm welcome and an orientation on board Solitude Gaia Palau. Boarding starts at 5:00 pm on Day 1 and concludes by 10:00 am on Day 2. Complimentary airport and local hotel transfers are available. As you step aboard, our team eagerly awaits to greet you. Registration and the collection of Permits and National Parks fees will follow. Remember to bring your C-Cards and/or Log Books. After settling into your comfortable accommodations, enjoy a delicious lunch and dinner, both included in your package, as you familiarise yourself with the vessel and meet fellow adventurers.

Day 2

Gives the opportunity of a possible 2 to 3 dives.

Choice of Sites: Helmet Wreck, Chandelier Caves, Jake Seaplane, Teshio Maru

Today marks the start of your diving adventure and your first dive. Solitude Gaia Palau will remain anchored in Malakal Bay, just off the shore of the

main town. This area holds significant historical importance as it served as the focal point of a major battle between the US and Japanese armed forces during World War II. Within close proximity to the bustling town of Koror, you will discover numerous shipwrecks from that era, providing the opportunity to explore both sunken vessels and an airplane wreck. Additionally, a popular and easily accessible cavern dive awaits you in the nearby Chandelier Caves, nestled within a rock island. This beginner-friendly cavern/cave dive showcases four distinct air chambers within a spacious cavern, where guests can ascend into these ample air chambers and marvel at the remarkable stalactites that adorn the limestone cave's ceiling.

Today, you will embark on a unique Palau diving experience, immersing yourself in the rich history and diverse array of dive sites within this small island nation. While the visibility in this area may not be as crystal-clear as one might expect from Palau's renowned blue waters, it adds an air of mystery to the overall experience. We will remain



anchored here overnight, allowing you to fully embrace the allure of this captivating location.

Day 3

Gives the opportunity of a possible 4 dives.

Choice of Sites: Iro Wreck, Helmet Wreck, Chandelier Caves, Buoy 6

Leave Malakal Lagoon Anchorage for Ulong Island after first dive.

As the sun rises, we find ourselves amidst the breathtaking limestone rock islands of Malakal Harbour. Today presents us with more opportunities to dive and discover the hidden gems within the inner lagoon. In the afternoon, we set sail towards the enchanting Ulong Island.

Day 4

Gives the opportunity of a possible 4 dives.

Choice of Sites: Siaes Tunnel, Siaes Corner/Ulong Channel, Sandy Paradise

Moored just off the stunning white sand beach of Ulong Island, we awaken to a day filled with incredible diving opportunities. The Ulong area beckons with its mesmerising walls, vibrant reefs, and dynamic currents. Drifting along these vertical walls gives you a sensation of soaring, as you marvel at the flourishing coral and abundant marine life. Schools of colourful reef fish gracefully ride the currents, while the corners teem with sharks, creating an exhilarating experience for those hooked on adventure. The pristine white sand and crystal-clear waters in this paradise-like setting accentuate the allure of the reef walls that plunge into the depths. Our stay in this captivating area extends into the night, immersing us in the true essence of Ulong Island.

Day 5

Gives the opportunity of a possible 3 to 4 dives.

Choice of Sites: Siaes Tunnel /Siaes Corner, Ulong Channel, Sandy Paradise

Leave Ulong Island Anchorage for Whole Island.

As the sun rises, we find ourselves still in front of Ulong Island, ready to embark on another

exciting dive in this area before heading further south. The exceptional visibility in these waters often captivates divers with its breathtaking wide-angle views of vibrant reefs and towering walls. However, if you pay closer attention to the reef itself, you'll discover that Palau is also home to an impressive variety of macro marine life.

In the afternoon, our journey takes us through the remarkable German Channel, a shallow passage carved through the reef during the German occupation to facilitate navigation between Palau's islands. Surrounding most of the country is a barrier reef, with the southern half encompassing the prestigious UNESCO World Heritage site known as the Rock Island Southern Lagoon (RISL). Due to the shallowness of the reef, larger ships must navigate the longer route along the outer edge of the barrier reef to reach the southern islands. Fortunately, our skiffs can traverse the German Channel, offering us a shorter and more convenient route to the southern dive sites.

The actual dive site of the German Channel is located south of the boat passage, where the channel's southern edge gradually slopes into the deep waters. It is in this area that Manta Rays gather to feed and seek cleaning stations, providing a mesmerising spectacle for divers. As we venture further south, we arrive at the southern outer reef, where some of Palau's most renowned dive sites eagerly await our exploration. While we delve into the underwater wonders during the day, Solitude Gaia Palau will embark on a lengthy journey via the eastern outer reef, circumnavigating the southern tip of Peleliu to reunite with us.

Day 6 to 9

Gives the opportunity of a possible 4 dives per day.

Choice of Sites: Peleliu Cut, Peleliu Express, Orange Beach/ German Channel, Blue Corner /Blue Holes /Turtle Cove, Big Drop Off/New Drop Off, Ngedebus Wall

We spend the next 4 days diving the current swept walls and corners of Ngemelis island, home of the Blue Corner and Blue Holes, Peleliu and Carp island. Clear water, stunning coral gardens, and massive schools of both big and small fish,



including an impressive number of sharks await. You'll have plenty of chances to navigate current and learn how to utilise a reef hook properly. During these days there is the potential for an optional Peleliu island WW2 land tour, dependent on guest interest and weather conditions (a dive must be skipped to fit the land tour into the daily schedule).

Day 10

Gives the opportunity of a possible 3 dives. Your last dive must comply with an 18-hour no-fly/no-altitude rule.

Choice of Sites: German Channel, Blue Corner, New Drop Off, Big Drop Off /Ngedebus Wall

As we reach our final day of diving, you have become a skilled diver adept at utilising the reef hook and mastering the currents of Palau. We will embark on our last dives, bidding farewell to the enchanting southern reefs of this remarkable destination. With each dive, we savour the underwater wonders one last time before we leisurely sail back to Malakal Harbour, cherishing the memories created during our unforgettable journey.

Return to Malakal Lagoon Anchorage in the late evening

Day 11, Disembarkation

No Dive Day

After a hearty breakfast, guests have the option to take complimentary speedboat tours through the Rock Islands and to the Milky Way. Note that a permit is required to visit these locations. Lunch will be served before disembarkation, followed by farewells to the crew.

Disembarkation commences after lunch and will conclude at 5:00 pm. Early disembarkation is possible, but please be aware that missed meals, tours, or dives due to this change are non-refundable and non-exchangeable. We look forward to welcoming you back soon!

Please note that the itinerary and planned route may be altered due to unfavourable weather conditions, sea conditions, or restrictions imposed by local authorities.

SOLITUDE WORLD

Liveaboard or Resort, we serve as your gateway to the Coral Triangle.

Solitude World is the ultimate destination for adventurers seeking to explore the pristine waters of the Coral Sea while enjoying the comforts of relaxed luxury.

We offer an extensive range of experiences, from encountering nudibranchs and unique critters to exploring bluewater reefs and big pelagics. Our three liveaboards, Solitude Adventurer, Solitude Gaia Palau and Solitude One, are carefully scheduled to coincide with the prime diving seasons in Raja Ampat, Banda Sea, Forgotten Island, Komodo, as well as in the Philippines and Palau.

Solitude Lembeh Resort is renowned as one of the critter capitals of the world, providing you with ample opportunity to explore from the black sand to the blue water, and even up to the local highlands.

We also offer Solitude Acacia Resort, located in the Philippines, which is the perfect destination for more macro critters especially nudibranchs and blackwater diving.

With Solitude World, you can rest assured that you will witness some of the world's most impressive marine creatures, and dive in the world's most abundant waters while experiencing the Solitude World's service and comforts.

Liveaboards

Solitude Adventurer Palau and The Philippines

Embark on an extraordinary voyage of exploration and immersion into the untamed beauty of the Indonesian islands with the Solitude Adventurer. This remarkable catamaran, a masterpiece conceived and custom-built by Austal in Australia, invites you to discover the raw nature that thrives both above and below the waterline. Originally launched as a family yacht to commemorate the new millennium for a prominent Singaporean family, the Solitude Adventurer has undergone meticulous transformations to offer unparalleled hospitality and diving experiences.

Step aboard and be captivated by the sheer magnificence of this 36m (118ft) long and 12m (39ft) wide vessel. Bathed in natural light and featuring an abundance of space, the Solitude Adventurer ensures your utmost comfort as you embark on unforgettable cruises to Indonesia's most awe-inspiring destinations. Prepare to be enchanted by the untouched splendour of Komodo, the Forgotten Islands, Raja Ampat, and beyond.

Above the waterline, towering cliffs stand majestically, framing the rugged landscapes that beckon exploration. From breathtaking viewpoints, gaze upon the awe-inspiring vistas that unfold before your eyes, only witnessed by a fortunate few. Below the waterline lies a world of wonder, where vibrant coral reefs teem with an astounding array of marine life. Dive into crystal-clear waters and encounter the captivating beauty that resides beneath the surface.

The Solitude Adventurer has been meticulously outfitted to cater to your every need and desire. Each detail has been carefully considered, ensuring your journey is one of utmost comfort and indulgence. Immerse yourself in luxurious amenities, relish delectable cuisine served in elegant surroundings, and unwind in spacious accommodations that blend modern elegance with a sense of tranquillity.

As you set sail on this extraordinary vessel, you embark on a voyage that transcends the ordinary. Discover the remote paradises of the Indonesian islands, where nature's wonders unfold in their purest form. Prepare to be enchanted, as the Solitude Adventurer invites you to experience a realm of untouched splendour and create memories that will last a lifetime.



Solitude One The Philippines

Embark on an unforgettable adventure with Solitude One, exploring the blue wonders of the Philippines—a must-visit destination for divers and ocean lovers alike. Dive into crystal-clear waters teeming with vibrant marine life, magnificent coral reefs, and awe-inspiring underwater landscapes. Immerse yourself in the rich biodiversity and captivating beauty of this pristine region, creating memories that will last a lifetime. Prepare to be amazed as you discover hidden treasures and experience the unparalleled magic of these remarkable underwater realms.

Originally a merchant's vessel, the MV Solitude One has been rebuilt to set new standards in hospitality and professionalism. Equipped with the latest onboard technology, it ensures the comfort and safety of all guests throughout their journey.

The dive deck, conceptualised and designed by experienced dive professionals, offers everything you need for a fantastic dive within arm's reach. With ample space to accommodate up to 24 divers, it provides storage for scuba equipment, accessories, video and photo gear, rinse tanks, and even features six freshwater showers. Your needs are carefully attended to, both before and after your dive.

This extraordinary vessel marries thoughtful design and layout with the functionality and comforts reminiscent of home. The MV Solitude One promises a truly enriching experience for its valued guests, ensuring they feel at ease throughout their journey.



Resorts

Solitude Acacia Anilao, The Philippines

Solitude Acacia, located in Anilao, The Philippines, has undergone a remarkable transformation. Formerly known as 'Acacia Resort and Dive Centre,' it partnered with Meseta Corp in 2018 to bring a fresh and contemporary design, elevating the resort to new levels of quality and professionalism under Solitude World's management. Our commitment is to provide an exceptional experience for our guests.

Immerse yourself in a breathtaking dining experience at our botanical restaurant, situated on the second level with 180° glass walls that offer panoramic views of the ocean and pool. Our modern and stylish restaurant provides the perfect setting to savour a variety of local and

international cuisine. Whether you choose the air-conditioned glass-walled area or the al fresco dining option, you'll be surrounded by the beauty of our resort.

Our fully equipped dive centre is designed to cater to divers of all levels, including beginners. With a contemporary and functional design, we offer courses and training in our spacious classroom that can accommodate up to 12 students. Additionally, our resort's swimming pool provides a convenient and safe environment for dive training.

Solitude Acacia Resort welcomes guests with 25 spacious and well-appointed rooms, featuring a fresh new contemporary design. Each room is thoughtfully crafted to blend modern aesthetics with the natural surroundings, ensuring a comfortable and stylish retreat amidst the tropical gardens.

Solitude Lembeh Resort Lembeh Strait, Indonesia

Located on just over half a hectare in North Sulawesi, Indonesia, Solitude Lembeh Resort is a remarkable retreat, rich with a history of cherished friendships and enduring values. The resort's distinctive blend of cultures and fascinating past make it a truly one-of-a-kind destination.

Guests have a choice of two Seafront Villas, eight Garden Villas, and eight Deluxe Rooms, all thoughtfully designed to provide an authentic and comfortable experience. Combining traditional Indonesian architecture with modern amenities, each villa offers a cozy ambiance, perfect for relaxation. The resort's primary goal is to create a peaceful and restorative haven, giving guests the opportunity to recharge.

The Solitude team is dedicated to ensuring every moment of a guest's stay is memorable, delivering experiences that leave guests feeling revitalized and connected.

Lembeh Strait: A Diver's Paradise

Lembeh Strait is one of the world's most renowned dive destinations, a must-visit for any diver in

Indonesia. Famous for its incredible diversity of critters, many species—such as the Hairy Octopus and Lembeh Sea Dragon—are found only in this local area.

Divers can enjoy mild currents, minimal surge, and shallow dive sites, making it an ideal for both beginners and experienced photographers. Water temperatures vary throughout the year, with the coolest months being July and August when temperatures drop to around 25°-26°C (79°-81°F). For your comfort, we recommend bringing a 3mm wetsuit with a vest or a 5mm wetsuit, especially if you plan to dive frequently. Additional layers are available for rent if you find you need more warmth.

While macro photography and critters are our primary focus, we also venture outside the strait to explore beautiful wide-angle opportunities. Divers will encounter breathtaking coral gardens, towering sea fans, and expansive seascapes perfect for wide-angle shots. Visibility is occasionally excellent, reaching up to 40 meters on the East of Lembeh. Inside the strait, average visibility is around 10 meters, but for our purposes, visibility is rarely a concern.



CONTACT FORM



CONNECT WITH US

Our team is thrilled and prepared to assist you in planning your next adventure with us. Keep in touch by scanning the QR code and let the journey unfold.

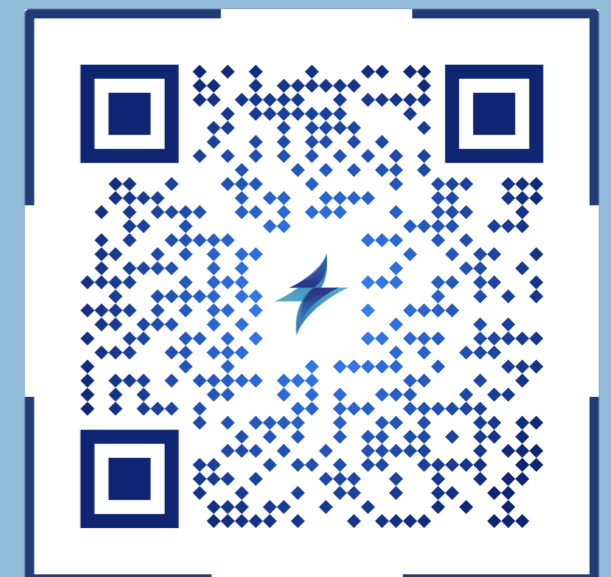

EMAIL US



Join 3SIXTY & Enjoy Exclusive Solitude World Benefits.

Joining the **3SIXTY** program is complimentary and unlocks a world of opportunities with Solitude World for guests who book directly with us online or through the Solitude World reservations team. This program is our way of showing appreciation to our valued guests with exclusive benefits and privileges.

As a **3SIXTY** member, you'll effortlessly manage your personal information, access current and future bookings, and track your tier levels and benefits. You'll also have the opportunity to view and accept exclusive tokens of our appreciation, enjoy priority access to specials and promotions, and discover all the benefits available to you as a valued guest.

At Solitude World, your passion for travel, discovery, and hospitality is at the heart of everything we do. By joining the **3SIXTY** program, you'll unlock exclusive benefits that elevate your Solitude World Experience across all our destinations, making each adventure even more memorable. **3SIXTY** is designed to celebrate your journey and enrich every moment of your time with us - a Thank You for being part of our world.

To learn more about your **3SIXTY** benefits and how to register, visit our website or reach out to our friendly team.

www.solitude.world

SOLITUDE SOCIALS

INSTAGRAM



FACEBOOK



Come and join us on our social media platforms to keep in touch, stay informed and become part of a lively community.



WWW.SOLITUDE.WORLD

www.solitude.world